

ESENA

RTV 2D1S

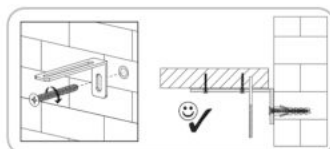

Ø8

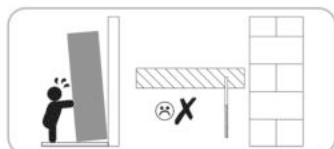
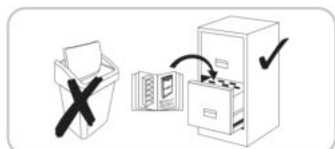
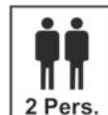
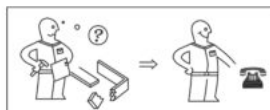
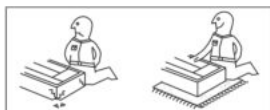
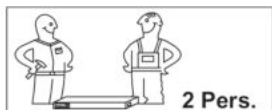
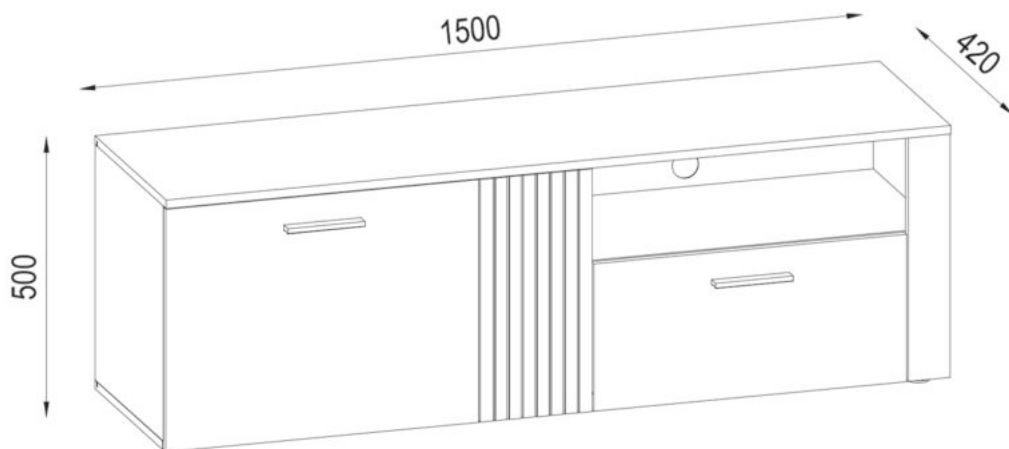

pevne dotiahnut



zatlačiť



odmerať



stlačiť



zabiť



otočiť - obrátiť

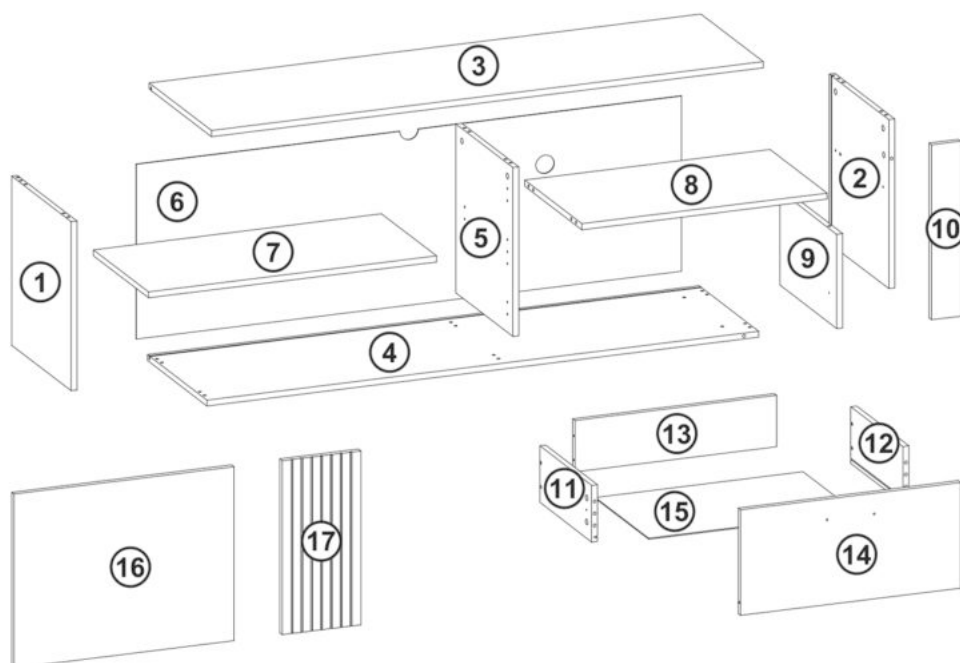















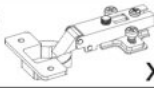





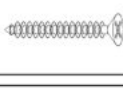

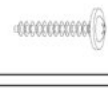

max. 3KG = 15 max. 5KG = 7 8 max. 10KG = 3 4

A	B (mm)		C	D
1	448	400	16	x1 1/2
2	448	400	16	x1 1/2
3	1500	420	16	x1 2/2
4	1500	400	16	x1 2/2
5	448	384	16	x1 1/2
6	464	1482	2,5	x1 2/2
7	783	370	16	x1 2/2
8	667	384	16	x1 2/2
9	250	384	16	x1 1/2

A	B (mm)		C	D
10	464	80	16	x1 2/2
11	350	150	16	x1 1/2
12	350	150	16	x1 1/2
13	548	136	16	x1 2/2
14	598	280	16	x1 2/2
15	564	358	2,5	x1 1/2
16	598	461	16	x1 1/2
17	461	214	16	x1 1/2
B1				1/2

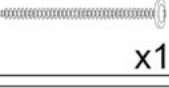

A1 15x12  x16	C2 44mm  x16	B2 8x30  x22
FA1 4mm  x1	F3 6,3x50  x10	O3 Ø18  x6
K6 Ø35  x4	J65 128/148  x2	O4 Ø18  x5
M1 10x10x15  x10	P14 45x20  x5	N1 Ø6  x4
D25 4x25  x5	DA21 4,2x16  x8	DB2 4x25  x4
E5 5x11  x4	D11 3,5x16  x10	D10 3x16  x4
R10 Ø10  x2	I6 350  x1	Y36 75x32x15  x1
	Y37 8x50  x1	Y35 4,2x65  x1
		R6  x1

Náš nábytok sa musí používať podľa predpisov. Použitie v rozpore s predpismi môže viesť k vecným škodám a za istých okolností aj k zraneniam osôb. Nábytok nie je hračka. Za škody, ktoré vzniknú používaním proti predpisom alebo nesprávnou manipuláciou, nepreberá výrobca alebo predajca žiadnu záruku.

POZOR: Deti alebo osoby s mentálnym postihnutím sa musia neustále držať mimo častí nábytku, špicatých predmetov, drobných častí a obalových materiálov, pretože hrozí riziko zranenia a/alebo udusenía.

MONTÁŽ: Pri montáži dodržiavajte náš návod na používanie, obsluhu, inštaláciu alebo montáž a dávajte hlavne pozor na výstražné a bezpečnostné pokyny. Pokiaľ sa nebudú dodržiavať predpisy, môže to mať za následok zranenie osôb alebo poškodenie nábytku/ohrozenie bezpečnosti. Ak by ste mali problémy s inštaláciou/montážou, kontaktujte náš servisný tím. Ochoťne vám poradí a pomôže. Montáž smie vykonávať iba kvalifikovaný personál. Pri zmenách na produkte/dieloch produktu, pri výmene alebo použití dielov/spotrebných materiálov, ktoré nepochádzajú od výrobcu/predajcu, nepreberáme žiadnu zodpovednosť za škody.

Pokiaľ sú k tovaru priložené upevňovacie prvky na stenu, ako sú hmoždinky a skrutky, sú tieto určené výhradne na použitie na stenách z pevných a jednoliatych materiálov. Upevnenie je len tak dobré, ako dobré je spojenie medzi upevňovacím prostriedkom a stenou. Pred upevnením musíte skontrolovať vhodnosť vašej steny pre stojaci aj zdvesný nábytok a použiť iba vhodné spojovacie prvky. Pred prípadným vitaním sa uistite, že sa v oblasti vitania nenachádzajú elektrické vodiče. Nakoniec je za upevnenie na stenu zodpovedný inštalčný technik.

Platí to aj pre inštaláciu elektrických produktov a ďalšieho stavebno-technického príslušenstva. Montáž/inštaláciu elektrických produktov a tiež ďalšieho dôležitého konštrukčného príslušenstva môže vykonávať iba autorizovaný kvalifikovaný personál. Všetky elektrické a stavebno-technické inštalácie musia byť vykonané v súlade s platnými normami a bezpečnostnými predpismi vo vašej krajine. Pre svetelné zdroje používajte iba povolenú intenzitu osvetlenia. Pri nedodržaní max. počtu Watt hrozí riziko požiaru v dôsledku prehriatia. Prekrývanie svietidiel nie je povolené z dôvodu rizika požiaru. Dokonalá funkcia nábytku je zaručená iba pri vertikálnej a horizontálnej inštalácii. Dvere sú vopred nastavené, môžu sa ale znova nastaviť na základe miestnych podmienok. Dodržiavajte údaje o hmotnosti pre maximálne zaťaženie. Na nábytok sa nesmie liezť. Pri neodbornom použití môže dôjsť k prevráteniu nábytku. Aby sa tomu zabránilo, musí byť nábytok neustále zaistený proti prevráteniu. Pri preťažení/nadmernom preťažení (najmä hrajúcimi sa deťmi, ľuďmi, materiálom alebo inými nevhodnými vplyvmi) hrozí riziko rozbitia a zranenia. Všetky skrutky a nosné spojovacie miesta by mali byť dotiahnuté po 5 až 6 týždňoch, aby sa zaisťovala trvalá stabilita.

STAROSTLIVOSŤ: Pokyny pre starostlivosť o nábytok - Dodržiavajte naše pokyny pre správnu starostlivosť o nábytok, aby ste si náš výrobok mohli užívať čo najdlhšie. Pri čistení používajte čistú, suchú a mäkkú bavlnenú handričku. Pokiaľ potrebuje váš nábytok dôkladné vyčistenie, môžete handričku navlhčiť trochu vody alebo čistiaceho prostriedku na nábytok a potom vyčistené diely vysušiť. Kovové a sklenené diely sa najlepšie čistia bežne dostupnými čistiacimi prostriedkami na kov a sklo podľa pokynov uvedených na výrobku. Na čistiacich prostriedkoch musí byť jasne uvedené, že sú vhodné na čistenie nábytku. V žiadnom prípade nepoužívajte pamé čističe, žieraviny, abrazíva alebo iné prostriedky, ktorých účinky nepoznáte. **POZOR:** Vysoko lesklé povrchy sú pri dodávke chránené ochrannou fóliou. Nechajte fóliu na nábytku, kým nebude úplne zmontovaný a zbavený prachu. Vysoko lesklé prvky, z ktorých bola odstránená ochranná fólia, je možné čistiť a používať až po 72 hodinách (doba pre následné vytvrdnutie na okolitom vzduchu).

Povrchy nemožno poškodiť ostrými predmetmi a nikdy ich nemôžete vystavovať silnému snečnému žiareniu.

LIKVIDÁCIA
- Pokyny na likvidáciu odpadu -
V záujme ochrany životného prostredia vyhadzujte obalový odpad roztriedený podľa druhu do určených odpadkových/recyklačných nádob, v žiadnom prípade nevyhadzujte do prírody. Poškodený alebo nepoužiteľný nábytok je možné odoslať do špeciálnych zberných zariadení na recykláciu jednotlivých dielov. Použitý, ale stále funkčný nábytok nie je nutné hneď likvidovať. Darujte ho napr. charitatívnym organizáciám.

Prajeme vám veľa zábavy s vaším novým nábytkom.

1

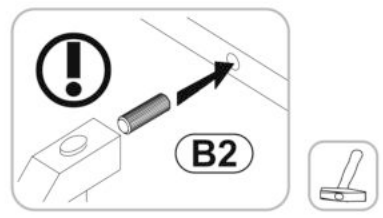
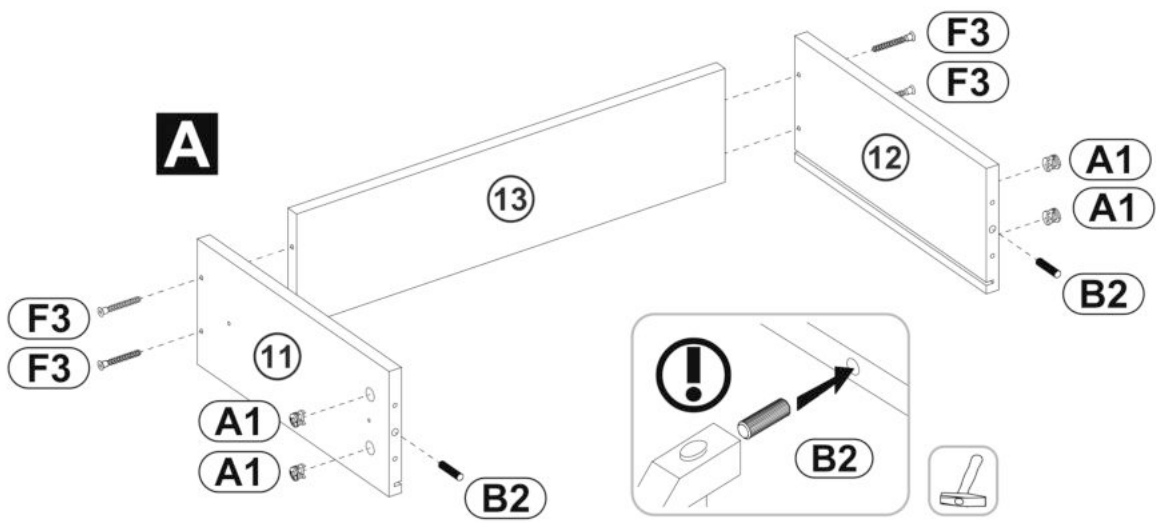
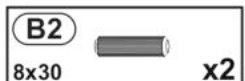
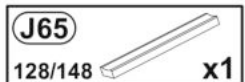
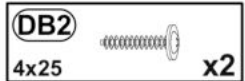
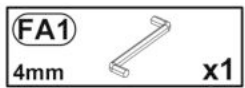
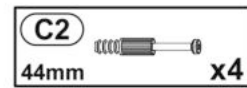
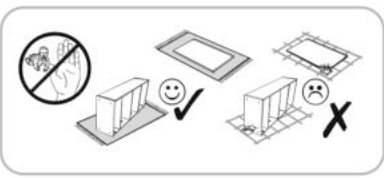

B

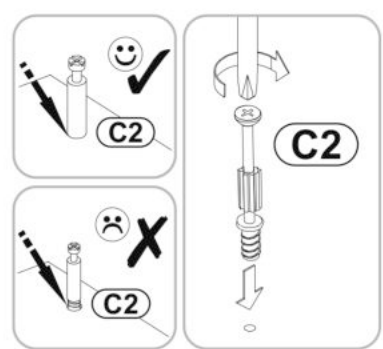
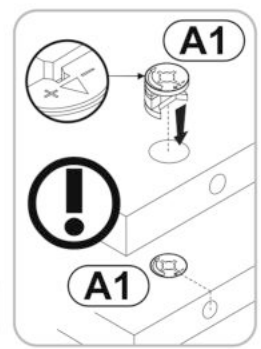
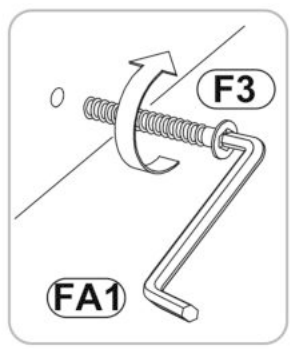
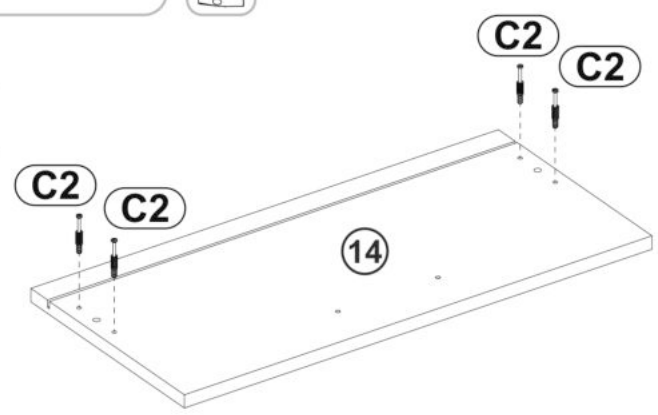

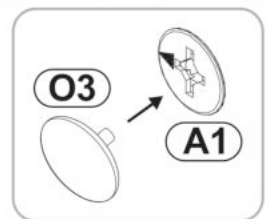
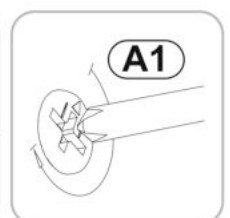
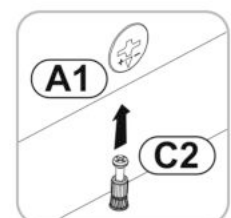
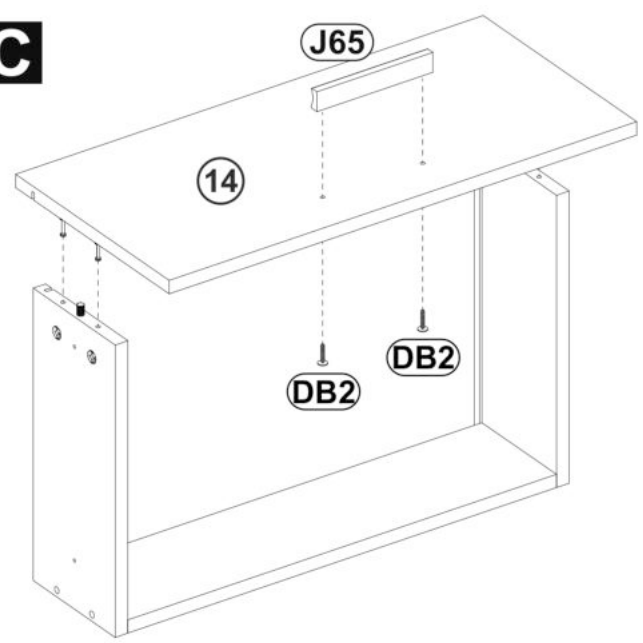

C

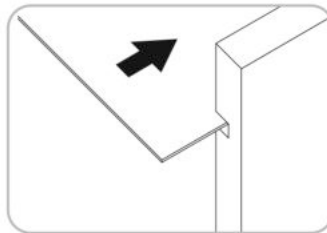
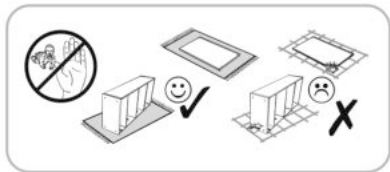

2



DA21 4,2x16		x4
I6 350		x1
D10 3,0x16		x4

D

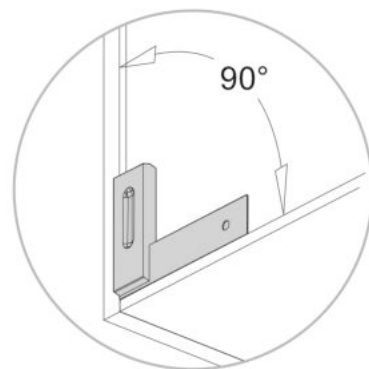
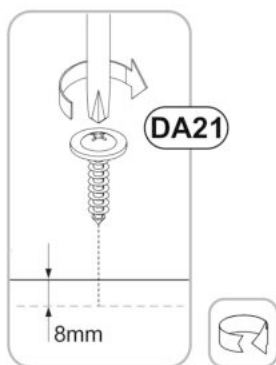
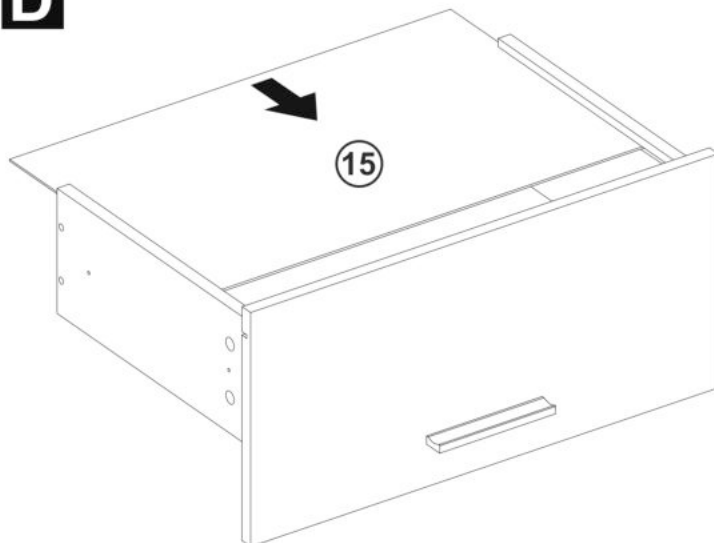

A=B

E

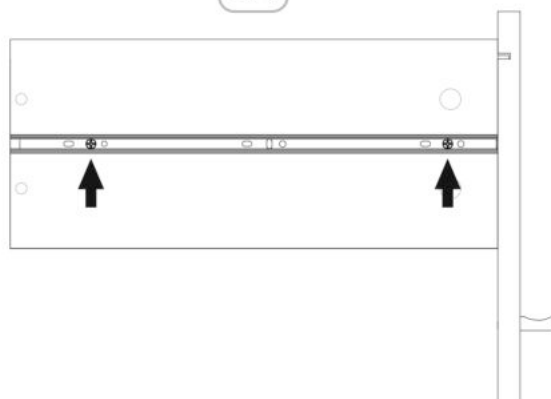
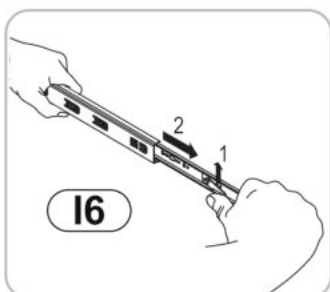
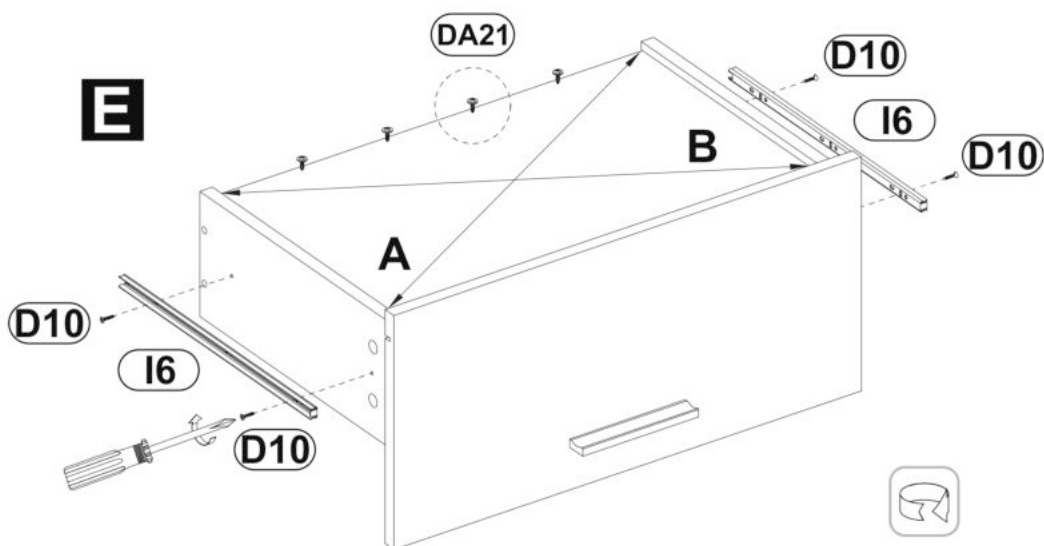

3

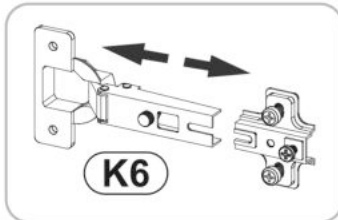
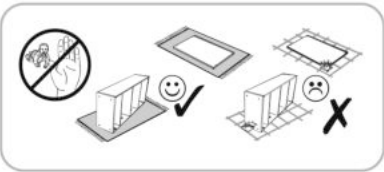

A1
15x12 x9

B2
8x30 x12

K6
Ø35 x2

C2
44mm x2

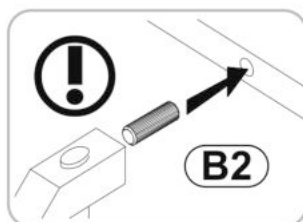
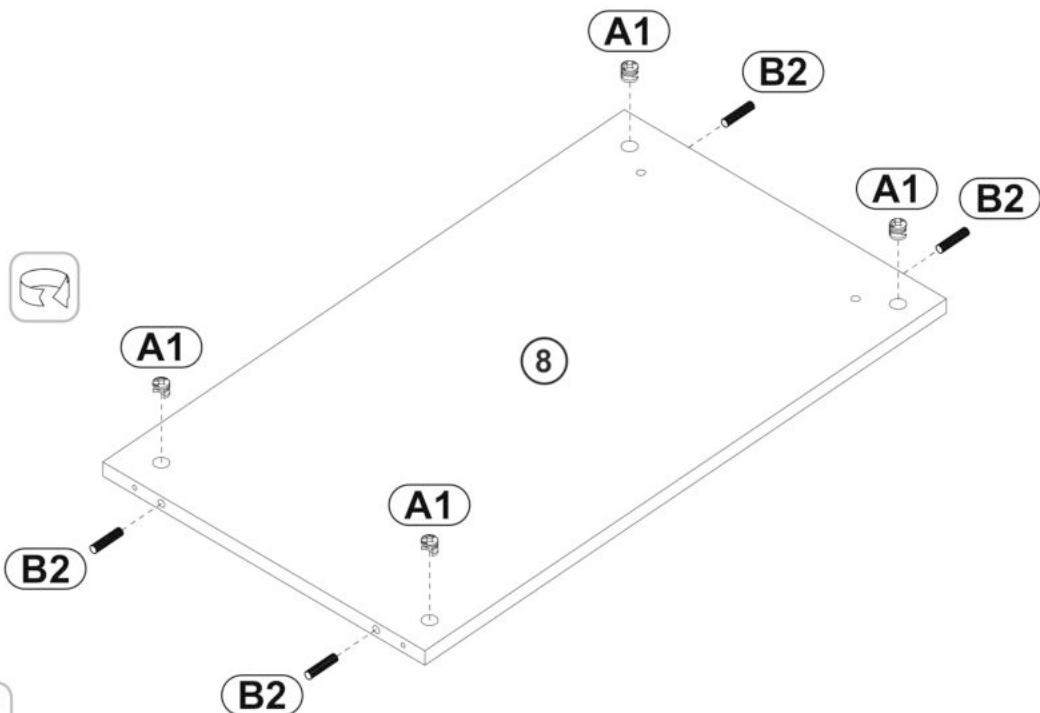
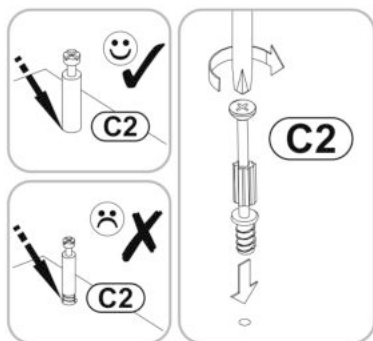
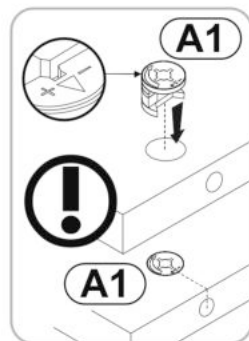
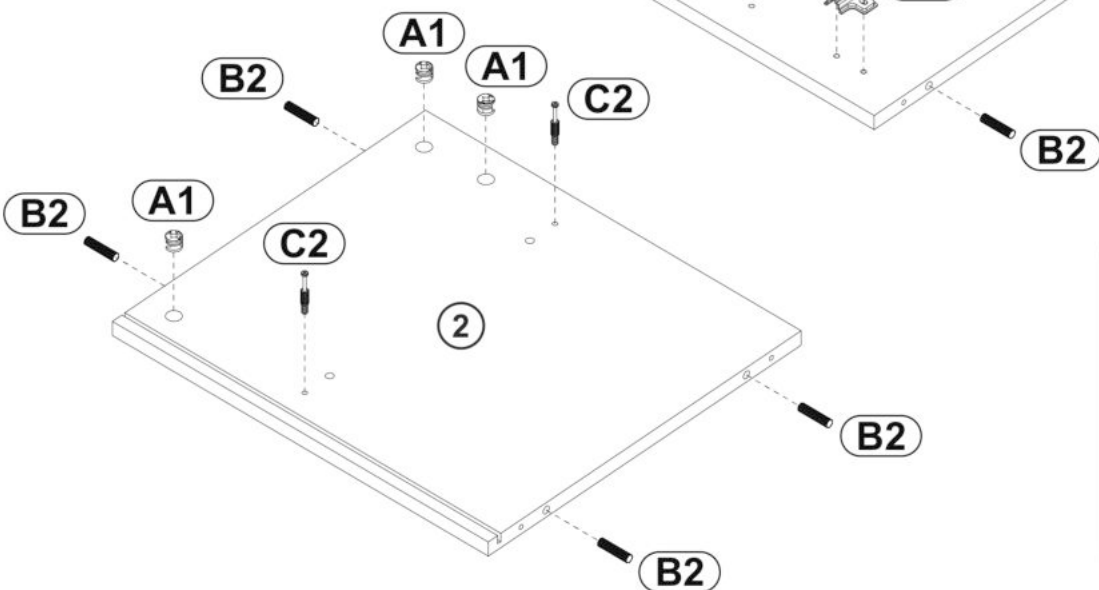
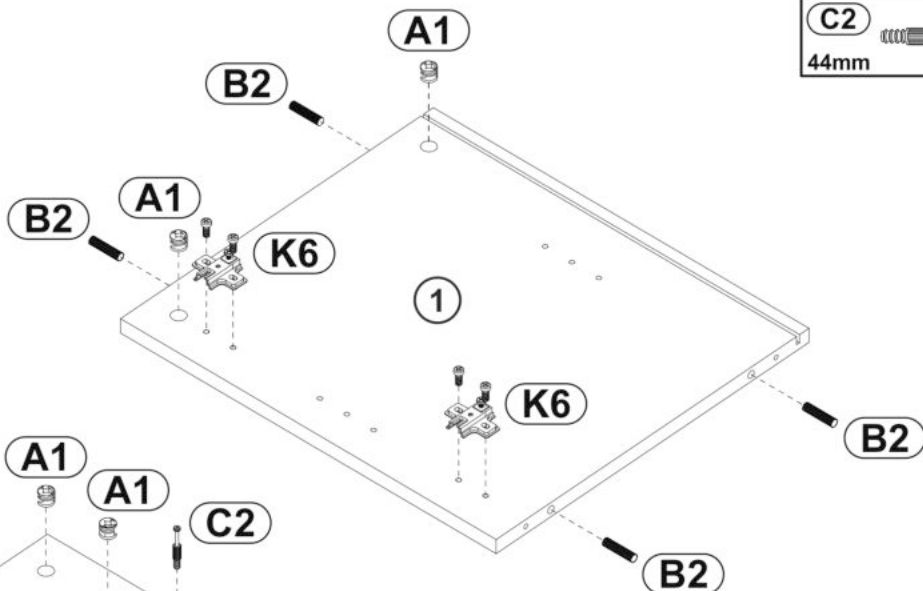
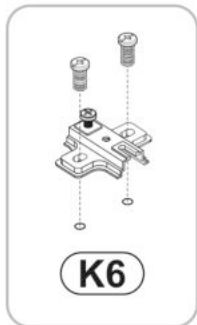

4

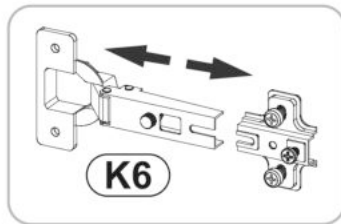
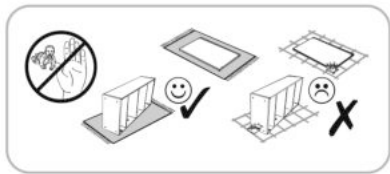

- A1** 15x12 x2
- C2** 44mm x2
- B2** 8x30 x8
- K6** Ø35 x2
- I6** 350 x1
- E5** 5x11 x4

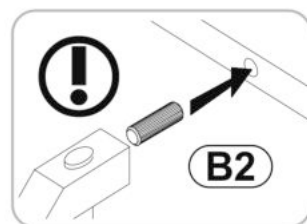
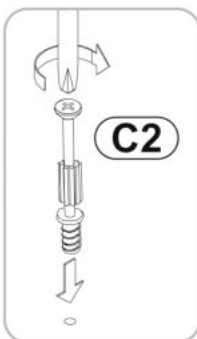
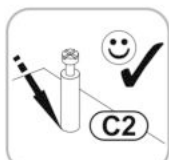
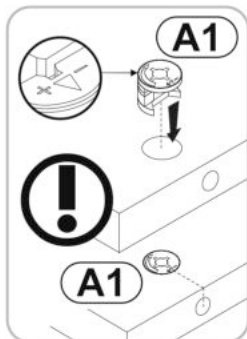
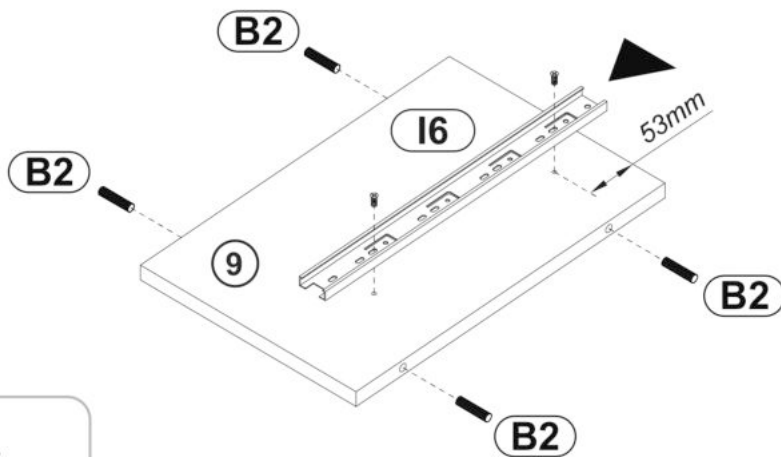
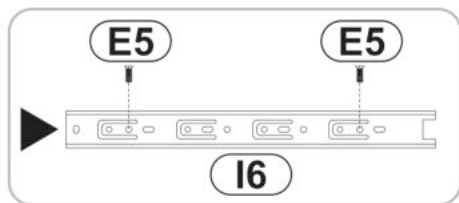
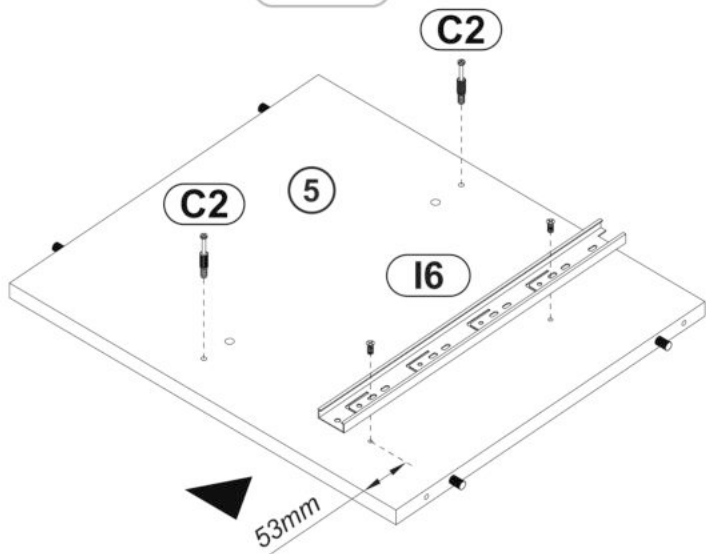
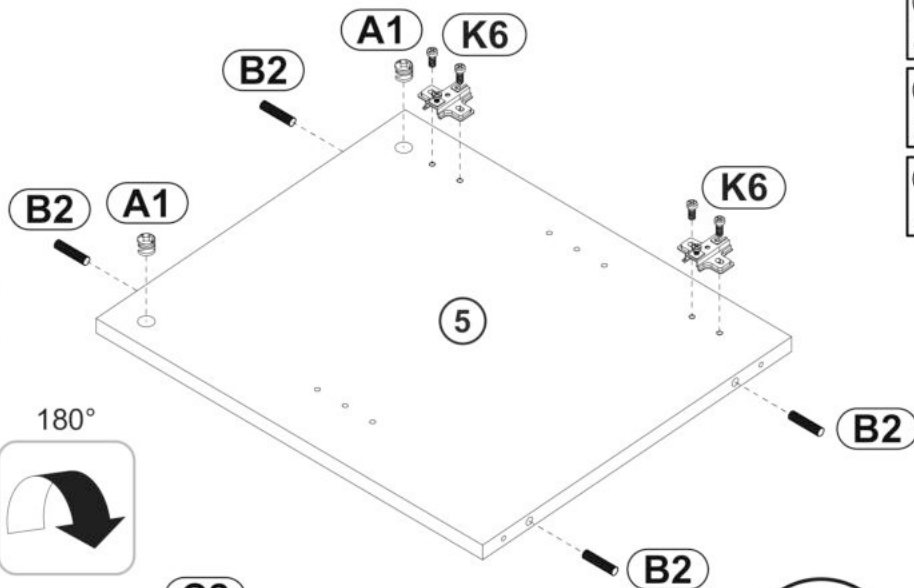
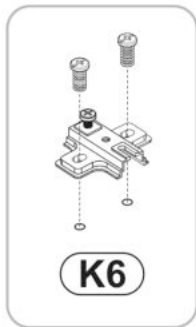

5

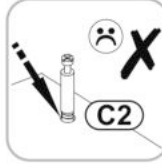
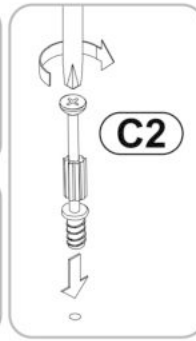
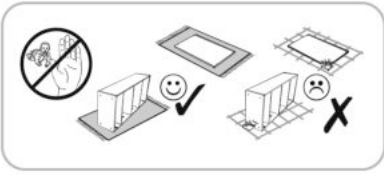

C2		44mm	x8
A1		15x12	x1
Y36		75x32x15	x1
D11		3,5x16	x2

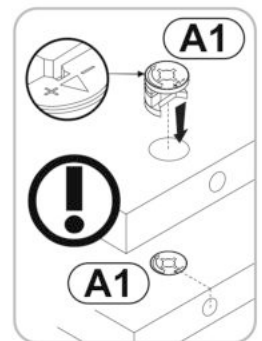
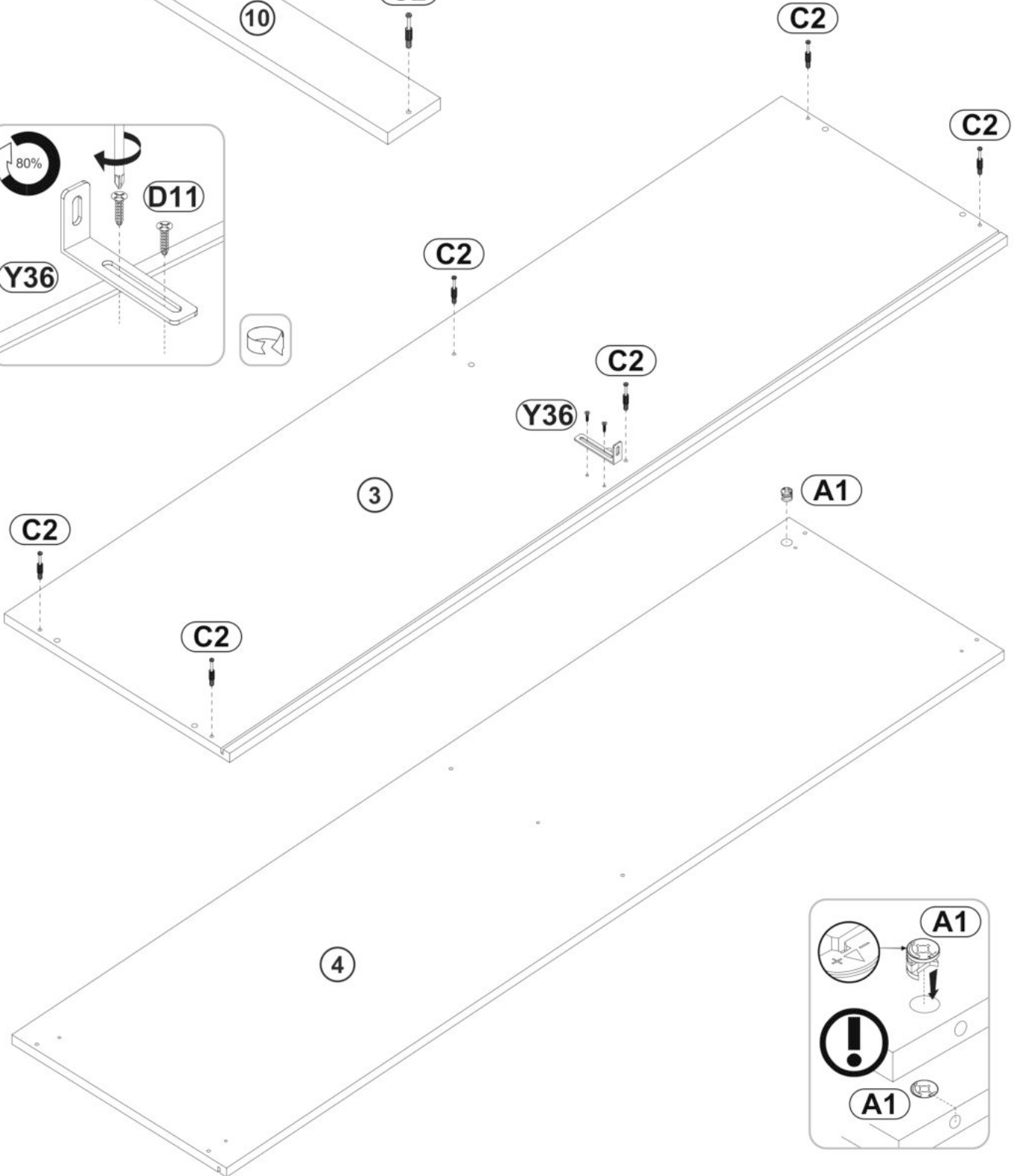
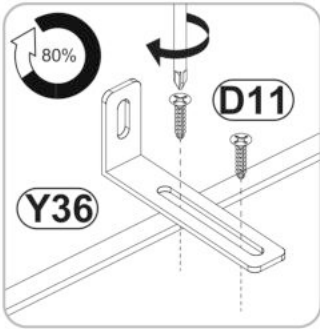
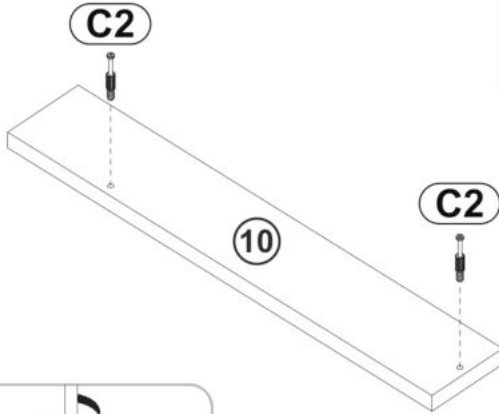

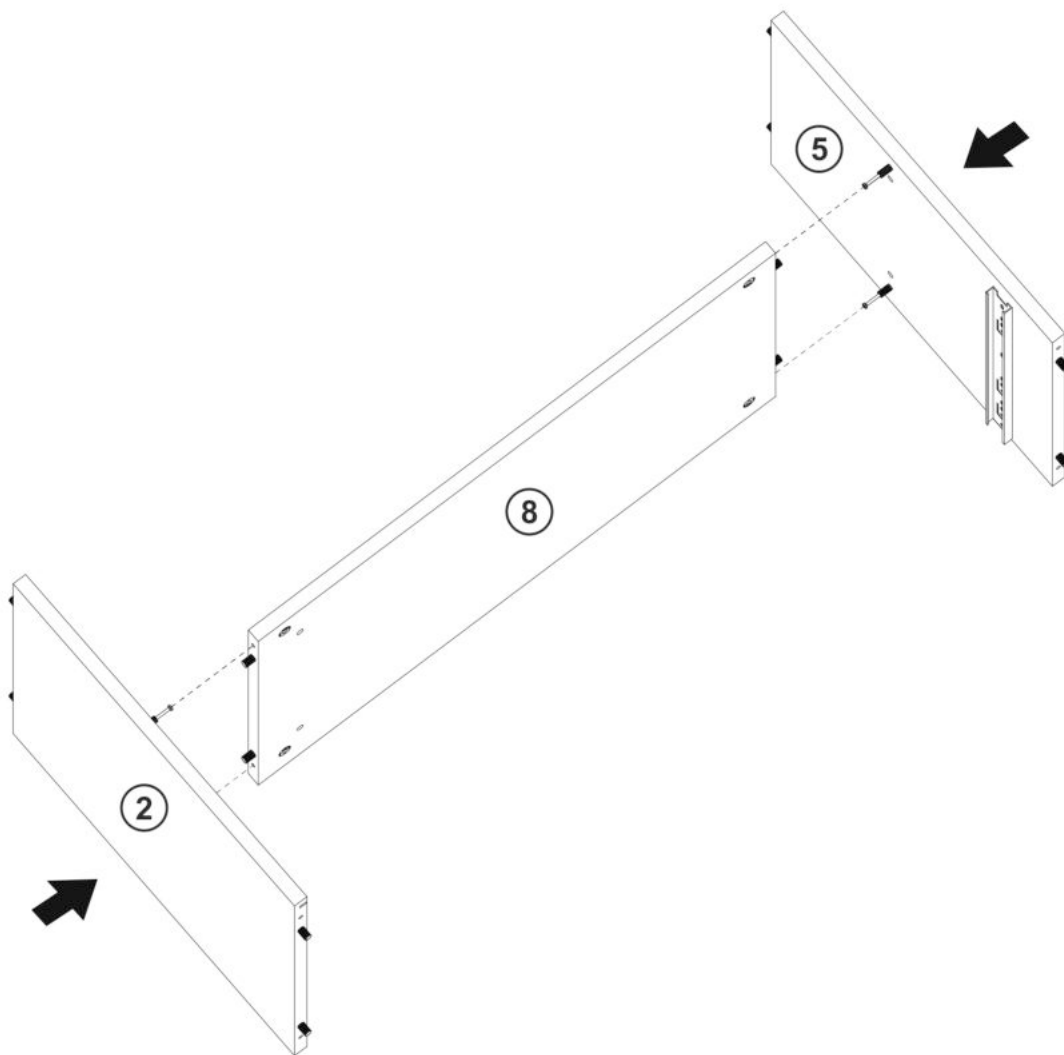
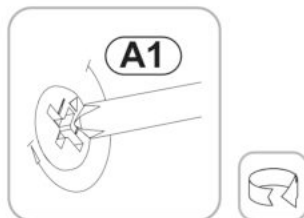
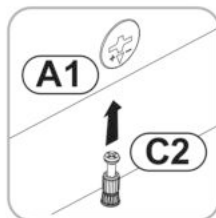
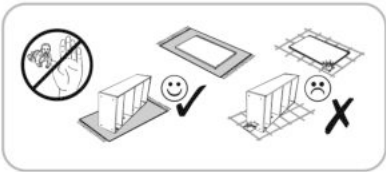

6

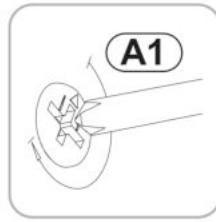
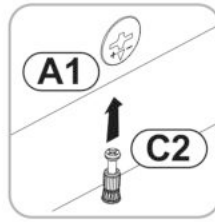
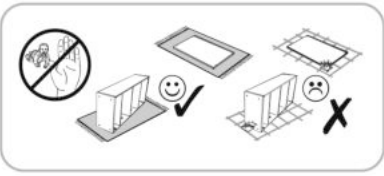

7



O4  x4
Ø18

O3  x2
Ø18

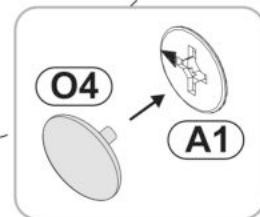
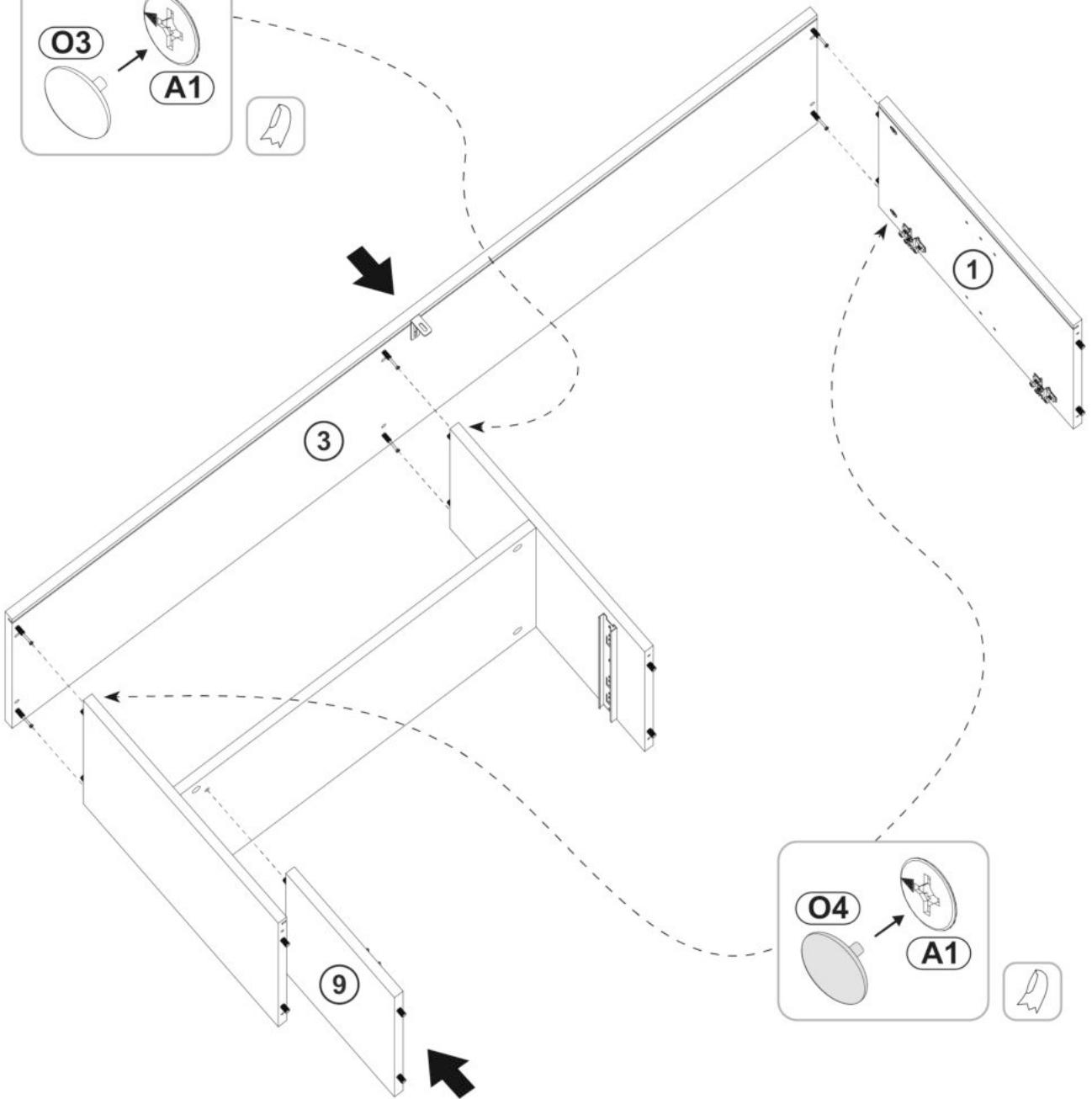
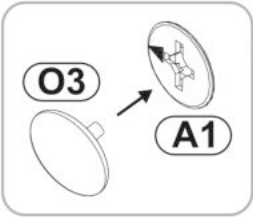

8

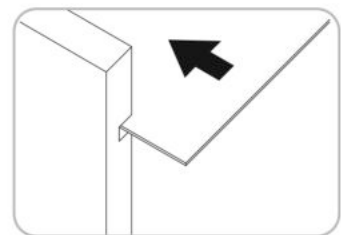
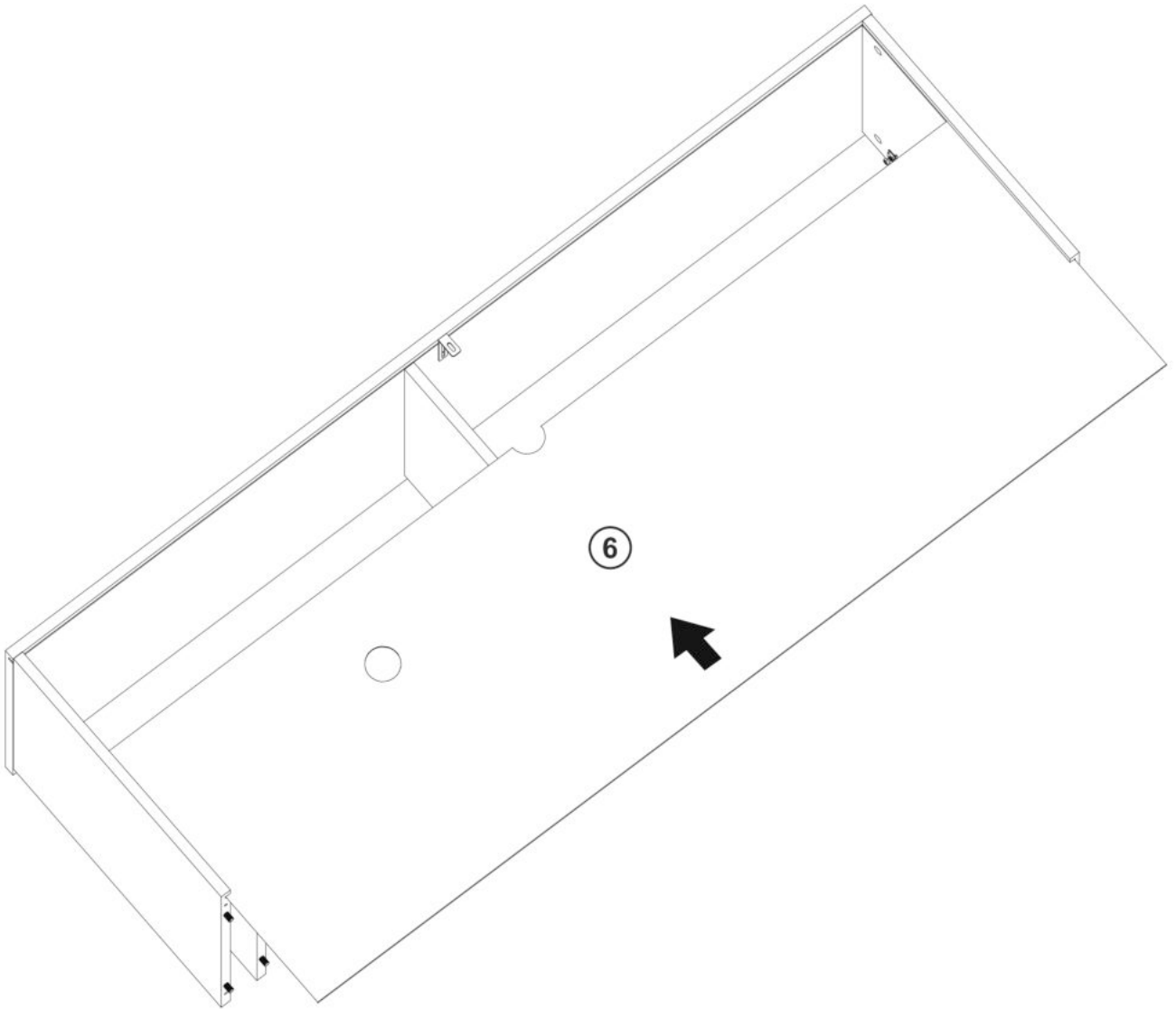
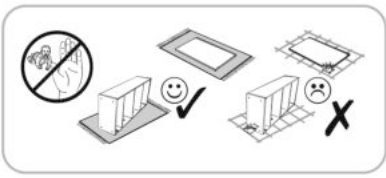

9

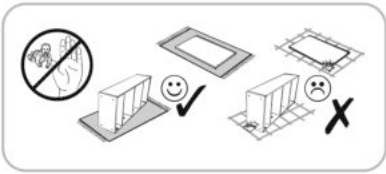

FA1
4mm x1

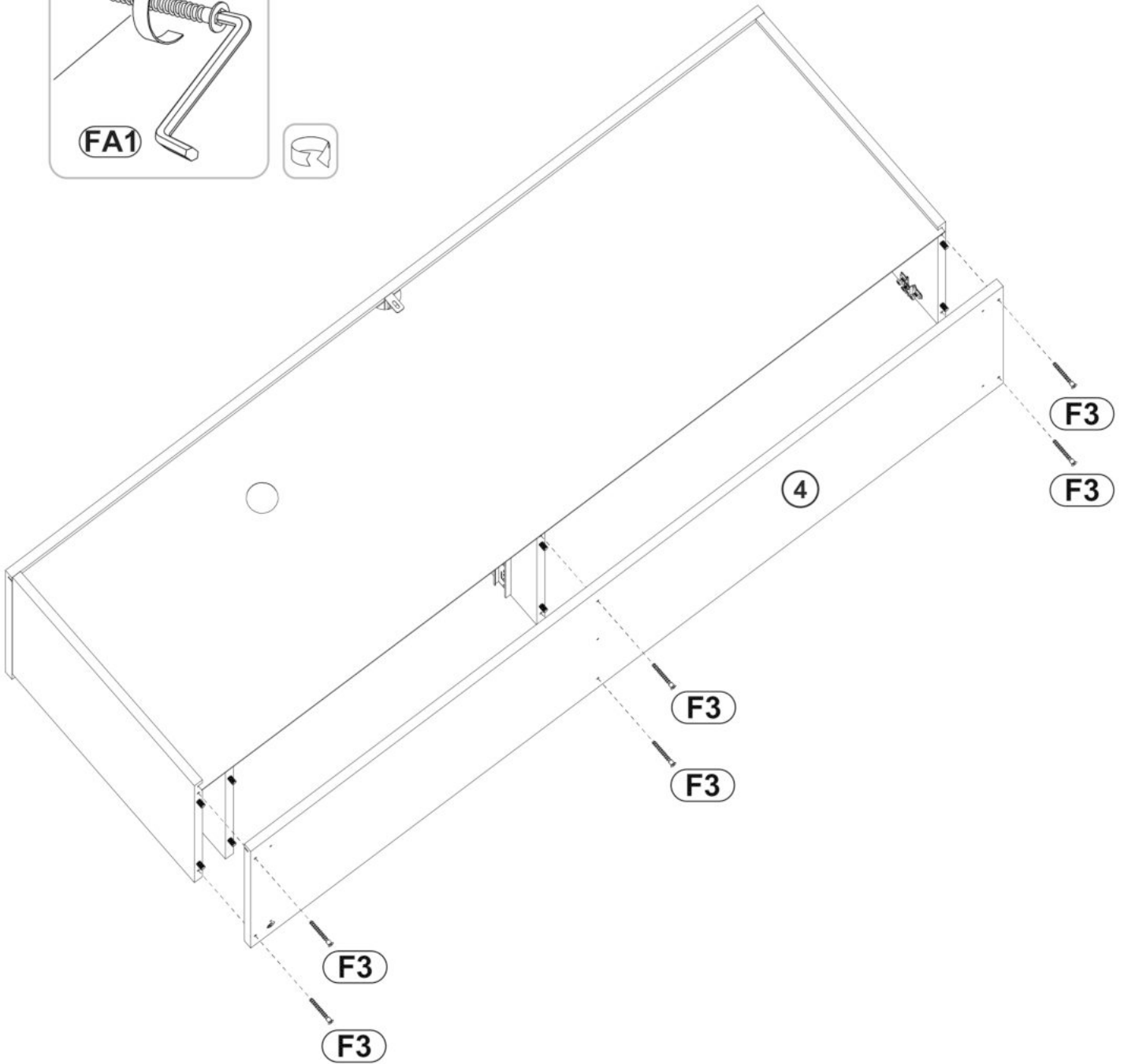
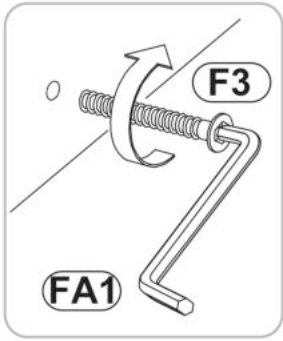

F3
6,3x50 x6

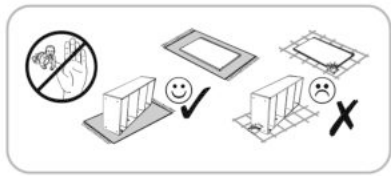

10

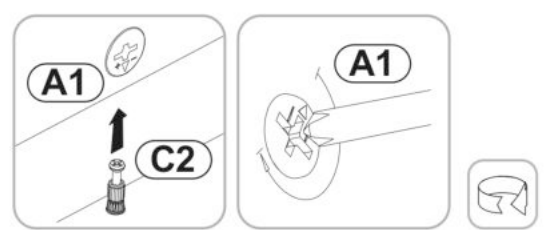
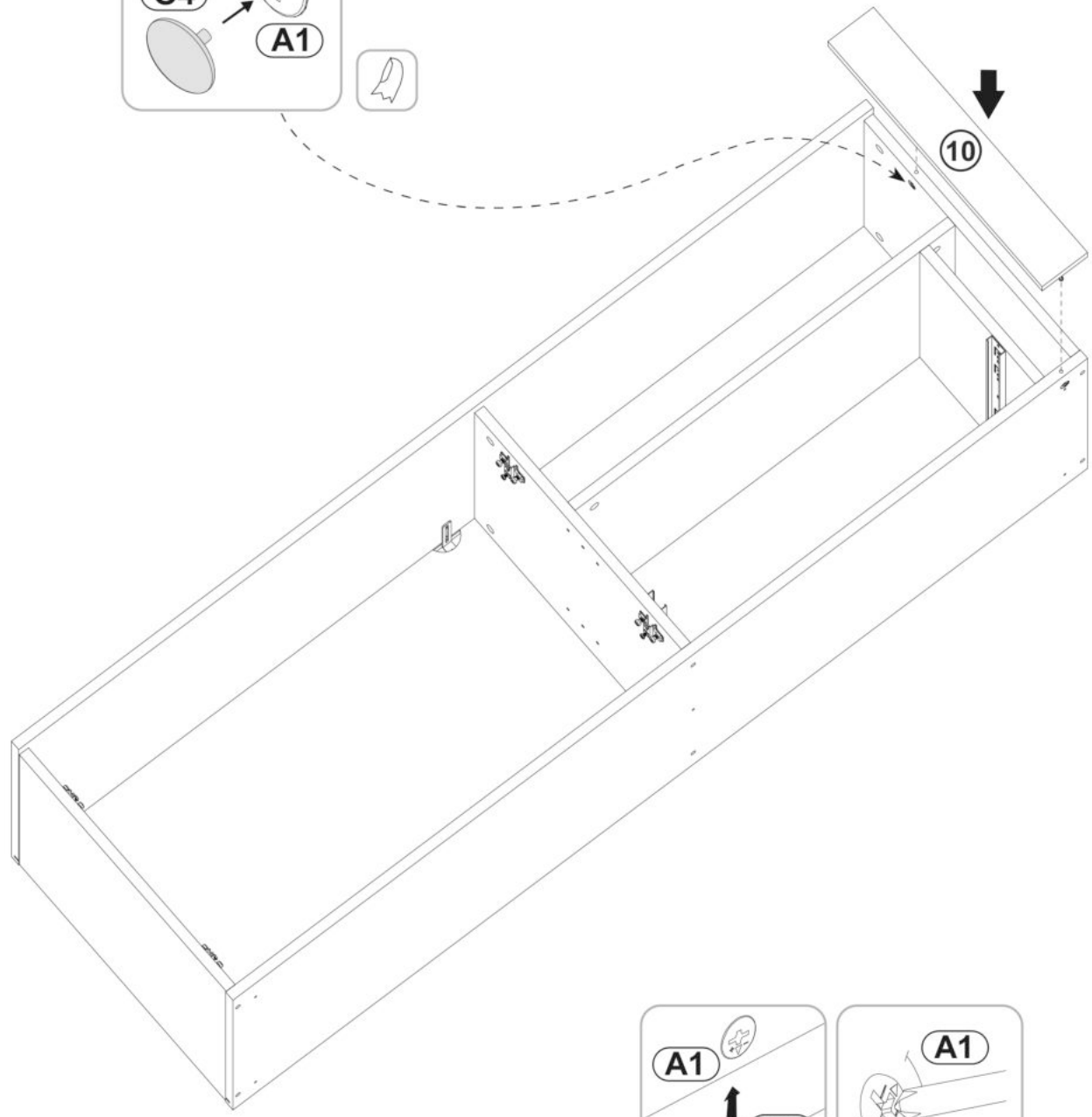
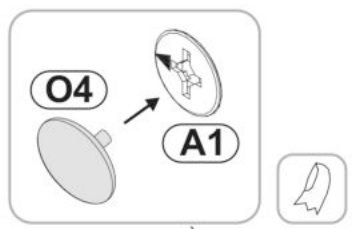

O4
Ø18 x1



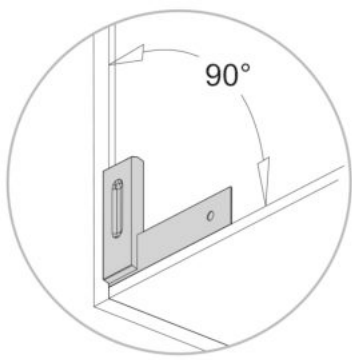
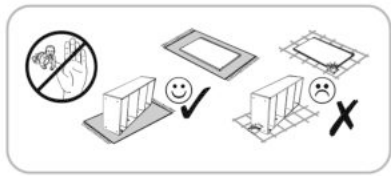

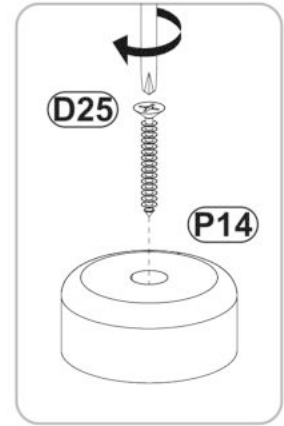
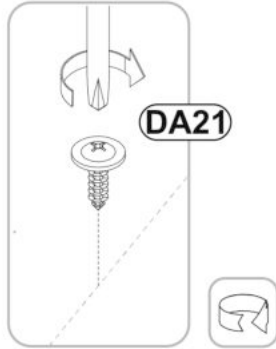
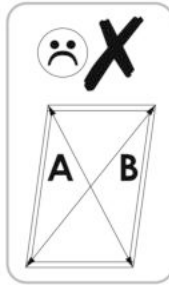
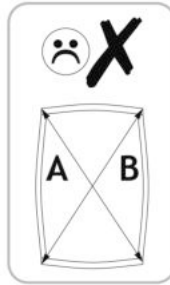
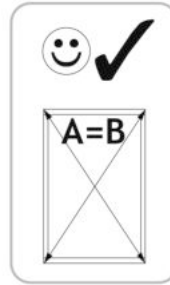
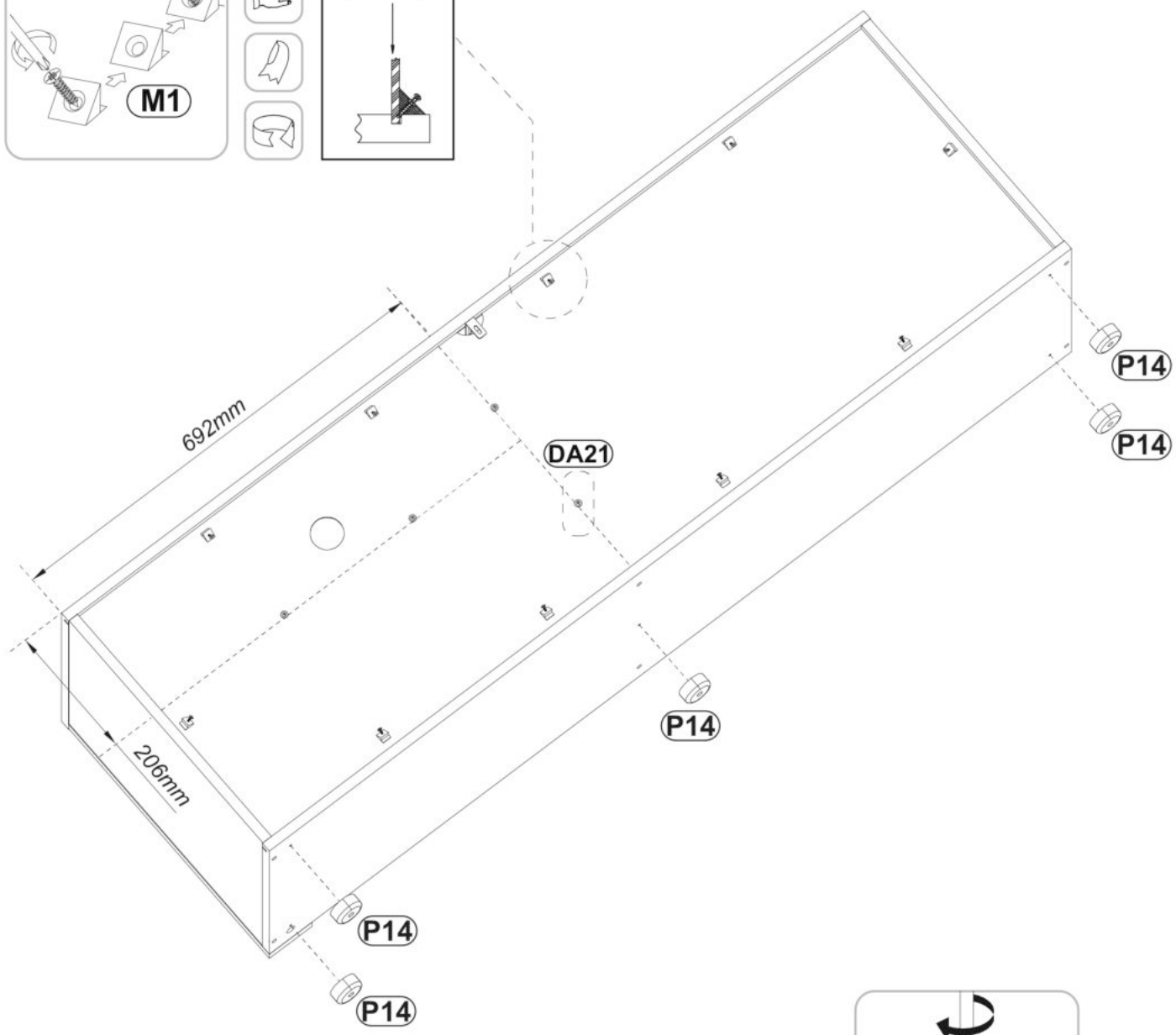
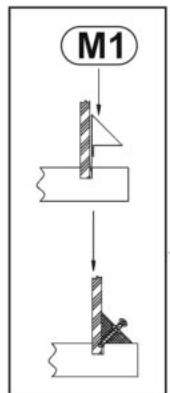
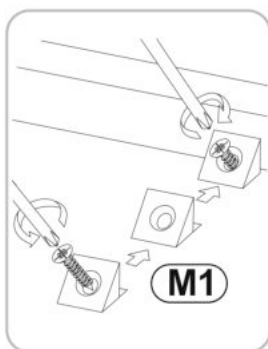

- M1**
10x10x15 x10
- DA21**
4,2x16 x4
- P14**
45x20 x5
- D25**
4x25 x5

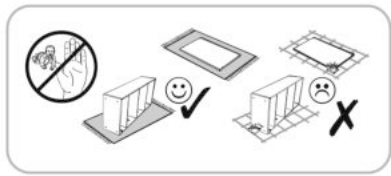





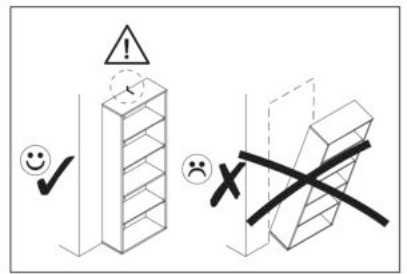
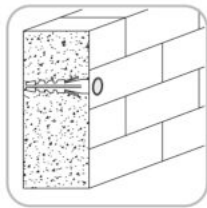
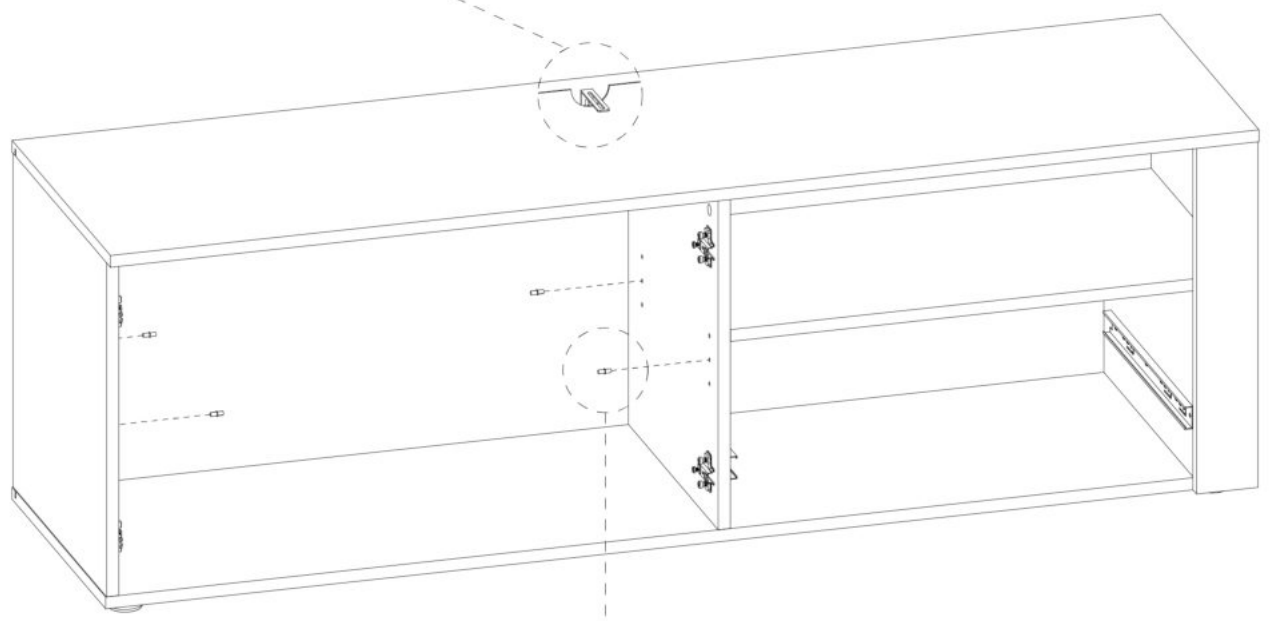
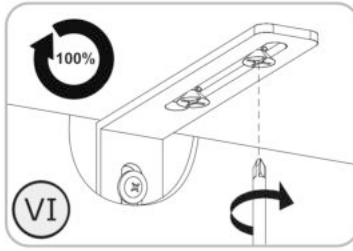
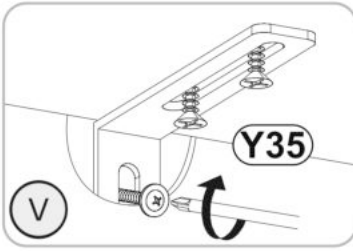
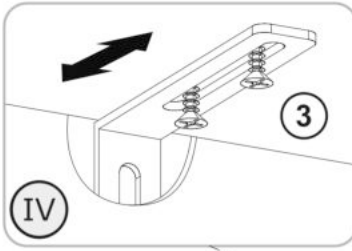
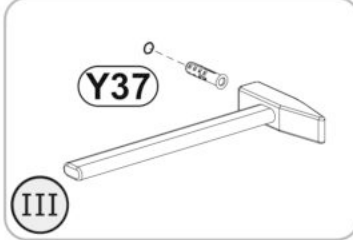
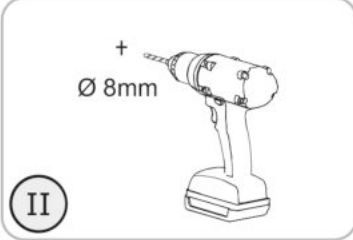
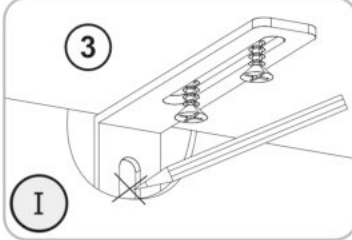

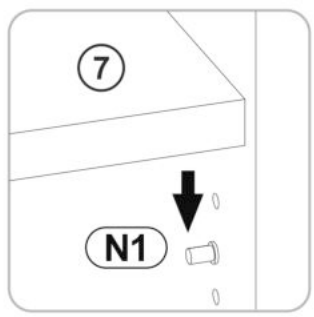
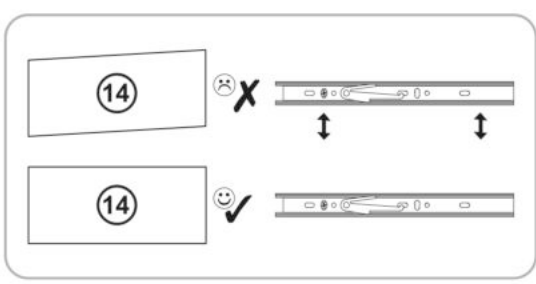
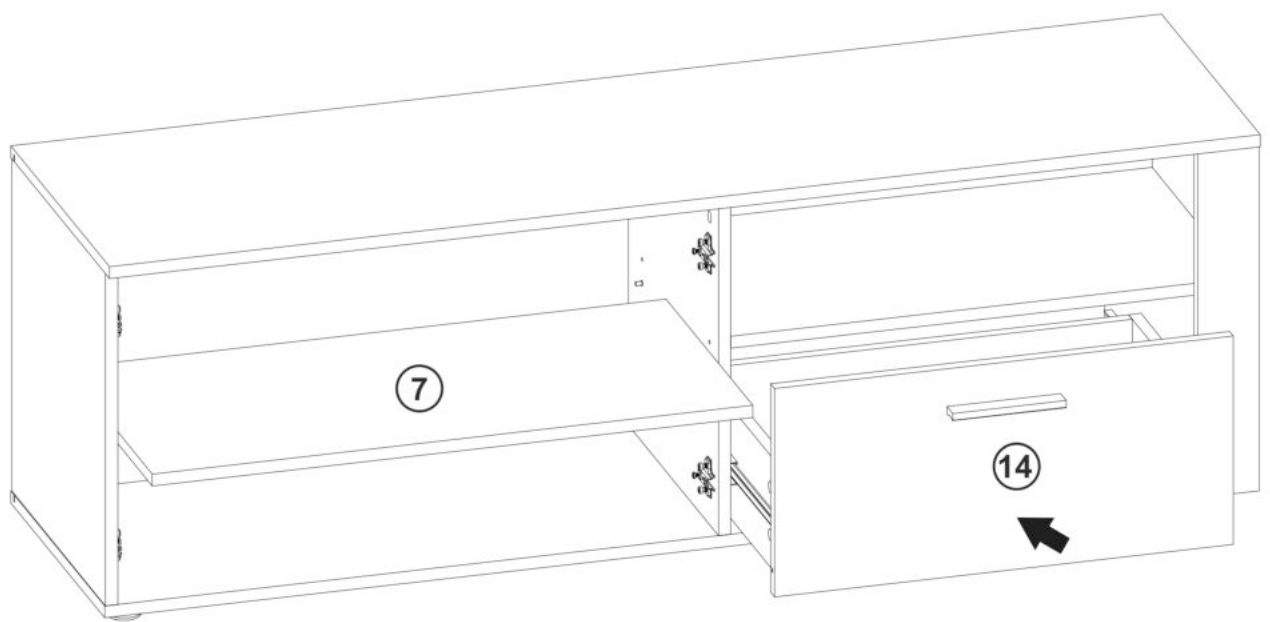
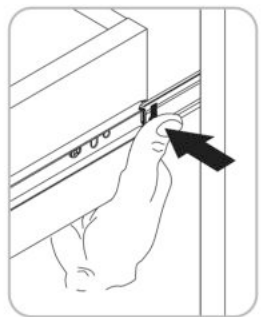
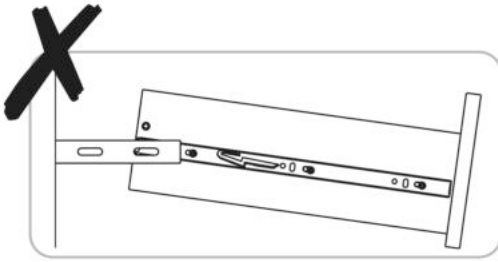
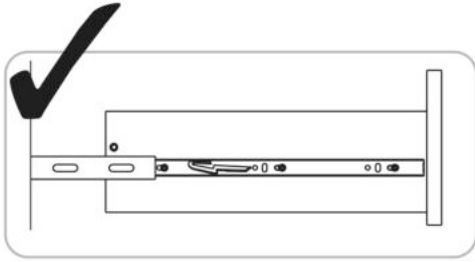
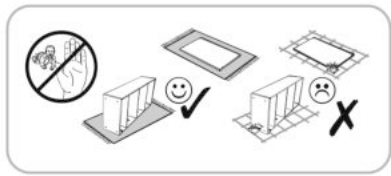
- (N1)**  x4
- (Y37)**  x1
- (Y35)**  x1

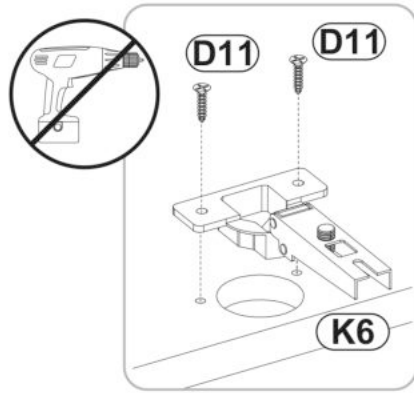
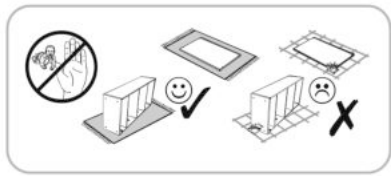

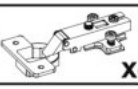



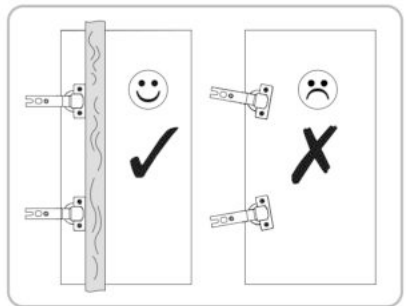
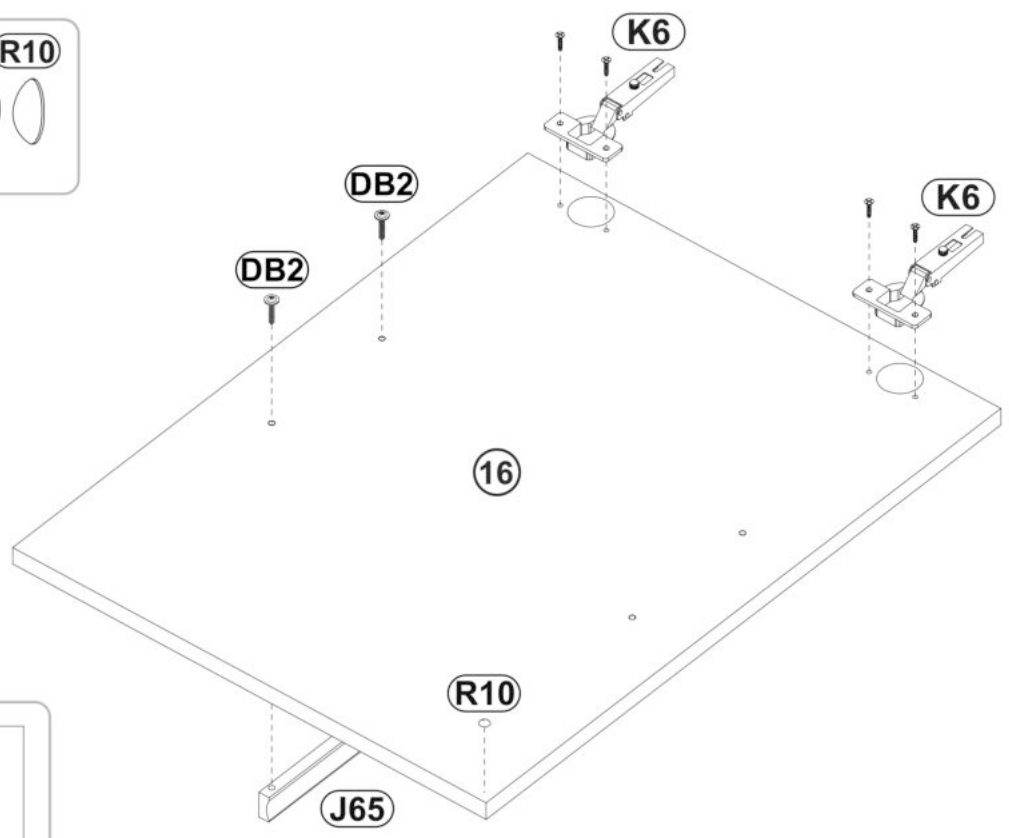
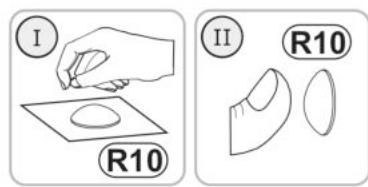
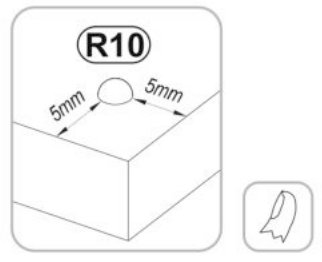
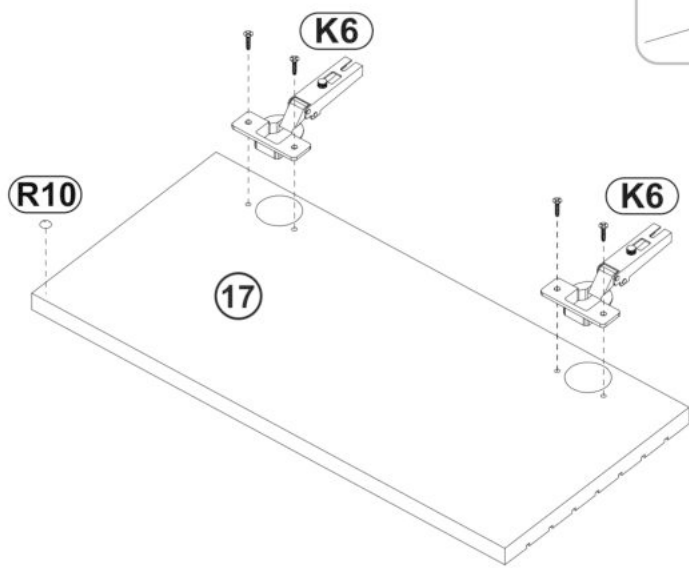

- K6**  x4
Ø35
- D11**  x8
3,5x16
- DB2**  x2
4x25
- J65**  x1
128/148
- R10**  x2
Ø10

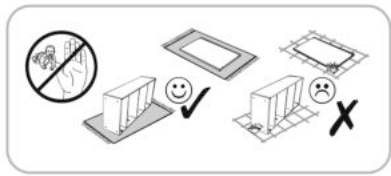

15



R6  x1

